

# 防爆灯具

## RDB98

防爆免维护节能灯(II B、II C、DIP)



### 适用范围 Application

- ◆适用于爆炸性气体环境1区、2区；
- ◆适用于可燃性粉尘环境21区、22区；
- ◆适用于II A、II B、II C级爆炸性气体环境；
- ◆适用于温度组别为T1~T6的环境；
- ◆可根据用户要求配带应急功能；
- ◆适用于石油采炼、储存、化工、医疗、军工及军事设施等爆炸性危险环境。

- ◆Applicable to Area 1 and 2 of explosive gas atmospheres;
- ◆Applicable to Area 21 and 22 of combustible dust atmospheres;
- ◆Applicable to IIA, IIB, IIC of explosive gas atmospheres;
- ◆Applicable to T1~T6 temperature group;
- ◆With emergency functions according to user requirements;
- ◆Applicable to petroleum mining, storage, chemical industry, military industry, military installation and other explosive dangerous environments.

### 型号含义 Model implication

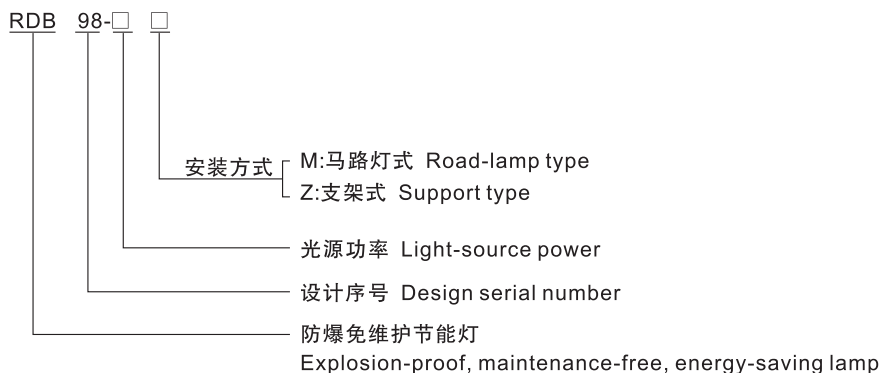

- 注: 1. 本系列灯具出厂时已配光源, 用户接入电源即可使用;  
2. 订货时请根据光源功率、附件逐项选型。

Note: 1. The series lamps are equipped with light source of electrodeless lamp and power source when delivery.  
2. Select model item by item according to light-source powers, installation ways and accessories when placing an order.

**RDB98**

explosion-proof maintenance-free  
energy-saving lamps(IIB、IIC、DIP)

**产品特点 Product feature**

1. 外壳采用铝合金高压铸成型，表面经抛丸后高压静电喷塑；
2. 高防腐性能不锈钢外露紧固件；
3. 光源腔与电源腔采用一体式结构，电源腔设有铰链，灯具安装更方便；
4. 光源腔与电源腔采用分离式结构，有效保证光源腔的热量不会传导至电源；
5. 特制高效率恒流恒压驱动电源，宽电压输入，恒功率输出，功率因数 $\geq 0.98$ ；具有多路分流、恒流、过压保护、过电流保护及突波电流保护功能。
6. 壳体与盖之间采用迷宫式曲路密封结构，配合耐热硅橡胶密封条，抗老化，防护等级高；
7. 抗4J高能量冲击的平板钢化玻璃板，抗热聚变、透光率高；
8. 模块化光源设计，利于灯具功率升级、更换，降低使用及维护成本。
9. LED光源采用国际知名品牌芯片，配合特制高效率恒流驱动电源，比气体放电灯节电达60%；
10. 专业光学设计的二次配光系统，光束分配合理，照度均匀，有效提高灯具光效；
11. 针对每种灯具类型专门设计的配光元件，泛光型及投光型，充分发挥灯具的使用性能；
12. 特制铝基板导热散热结构，确保光源工作时产生的热量及时有效的传导到散热片上，提高散热效率；
13. 壳体表面具有高密度散热片，大大提高散热面积，并能借助空气流动带走热量，充分保证LED的散热要求，使用寿命更长。
14. LED组件为全密封结构，防水防尘，无需内部清洁和维护；专门设计的模块电路，每单元故障不会影响其余组件的正常工作。
15. 无紫外线辐射，能为长时间在室内工作的用户提供优质照明与健康保障；
16. 壁式安装旋转角度可调，电缆布线，吸顶式安装可采用电缆或钢管布线；
17. 钢管或电缆布线。

1. Housing is made of aluminum alloy with high pressure casting formation and the high voltage electrostatic spray is carried out on the surface after shot blasting;
2. Exposed fastener is made of stainless steel with high antiseptic property;
3. One-piece structure is used for light source cavity and power source cavity, and the power source cavity is equipped with hinge, therefore, it is more convenient to install lamps;
4. Separate structure is used for light source cavity and power source cavity, so as to ensure that the heat in light source cavity can't be transmitted to the supply power;
5. It is specially to manufacture high efficiency, constant current and voltage driving source with wide voltage input and constant power output. The power factor is  $\geq 0.98$ . It has many functions of multichannel shunt, constant current, overvoltage protection, overcurrent protection and surge current protection;

### **RDB98**

防爆免维护节能灯(IIB、IIC、DIP)

- 6.Labyrinth seal structure is used between housing and cover to resist aging and have high protection level by combining with heatproof silicone rubber sealing strip;
- 7.Armorplate glass can resist 4J high energy impact and heat fusion as well as have high light transmittance;
- 8.Design of modular light source is good for power upgrade and replacement, reduce use and maintenance cost of lamps;
- 9.International famous Chip is used for LED light source. It can save 60% electricity than gas discharge lamp by combining with specially-made high efficiency, constant current driving source;
- 10.Secondary light distribution system is designed based on professional optical to have reasonable distribution of light beam and uniform illumination and effectively improve lighting effect of lamps;
- 11.Light distribution element is specially designed for each lamp type (flood type and project-light type) to give full play to use property of lamps;
- 12.Heat-conduction and heat-radiation structure of specially-made aluminum substrate can ensure the heat generated by light source to effectively transmit to cooling fin and improve heat emission efficiency;
- 13.Housing surface has high density cooling fin to greatly improve heating radiating area, take away the heat by air motion and fully ensure the cooling requirements and long service life of LED.
- 14.Fully sealing structure is for LED assembly with waterproof, dustproof, without internal cleaning and maintenance. Unit failure shall not impact on the regular work of other assemblies by especially designed modular circuit.
- 15.It can provide high quality lighting and health security for the user working in the interior for long time without ultraviolet radiation;
- 16.The rotation angle of wall type installation is adjustable and cable wiring is used for it. Cable or steel pipe wiring is used for ceiling type installation;
- 17.Cable or steel pipe wiring.

**RDB98**

explosion-proof maintenance-free  
energy-saving lamps(IIB、IIC、DIP)

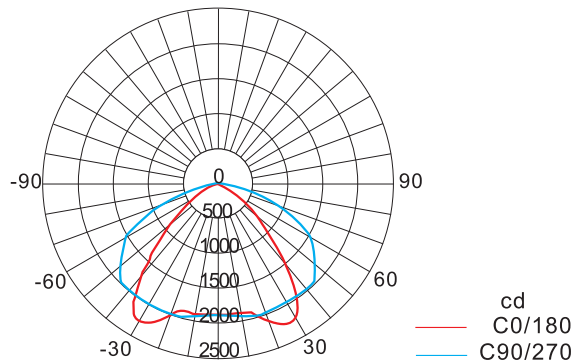
**配光曲线Distribution curve flux****主要技术参数 Main technical parameters**

执行标准 (Executive standard): GB 3836.1、GB 3836.2、GB 3836.3、GB 3836.9、IEC60079

防爆标志(Ex-mark): ExdembIICT6Gb/ExtD A21 IP65 T80℃

额定电压(Rated voltage): AC 220V

配备光源(Equipped light source): LED

额定功率(Rated power): 40W、60W、80W、100W、120W、150W、200W、300W

发光效率(Light source power):  $\geq 160\text{lm/W}$

功率因数(Power factor):  $\geq 0.98$

防腐等级(Corrosion-proof-class): WF1、WF2

引入口规格(Entry spec): G3/4"

适用电缆外径(Cable's outer diameter):  $\Phi 9\text{mm} \sim \Phi 14\text{mm}$

**LED光源特性 Light source features****发光效率高 High luminous efficiency**

白炽灯光效为7-14lm/W，高压钠灯80-100lm/W，大部分的耗电变成热量损耗。LED光效可达到140-160lm/W，而且其光的单色性好、光谱窄，色温可选定，显色性好。

Light effect is 7-14lm/W for incandescent lamp and 80-100lm/W for high pressure sodium lamp. Most of power consumption is turned into heat loss. Light effect is up to 140-160lm/W for LED with good monochromaticity, narrow spectrum, selected color temperature and good color rendering.

## RDB98

防爆免维护节能灯(IIB、IIC、DIP)

### 耗电量少 Low power consumption

LED单颗功率1-3W，采用直流驱动，单管驱动电压3-3.5V，电流0.35-1A，反应速度快，可高频操作。同样照明效果的情况下，耗电量是白炽灯泡的八分之一，荧光灯管的二分之一。  
Single LED power is 1-3W with DC drive. Driving voltage for single tube is 3-3.5V and current is 0.35-1A with fast reaction speed and high frequency operation. Under the same condition of lighting effect, its power consumption is 1/8 of that of incandescent bulb and 1/2 of that of fluorescent lamp.

### 使用寿命长 Long service life

普通光源采用电子光场辐射发光，灯丝发光易烧、热沉积、光衰减等缺点。而采用LED光源体积小、重量轻，环氧树脂封装，可承受高强度机械冲击和震荡，不易破碎。理论寿命达10万小时，可以大大降低灯具的维护费用，避免频繁换灯。  
Electronic field radiation emitting light is used for ordinary light source with easy fired lamp filament, heat deposition, light decay and other defects. LED light source can sustain high strength mechanical shock and vibration as well as is nonbreakable with small size, light weight and epoxy resin package. Theoretical service life is up to 0.1 million hours to greatly reduce maintenance cost and avoid frequently replacing the lamp.

### 安全可靠性强 High safe reliability

冷光源，无热辐射，能精确控制光型及发光角度，无眩光；不含汞、钠元素等可能危害健康的物质。  
It has cold light source and can accurately control lighting type and angel, without heat radiation, glare, as well as without mercury, sodium and other substances being harm to health.  
内置微处理系统可以控制发光强度，调整发光方式。  
Built-in microprocessing system can control light intensity and adjust light way.

### 使用成本低 Low use cost

LED光源比传统光源稍高，但是用一年时间的节能可收回光源的投资，LED属免维护光源，可节省以后几年的维修费用，大大降低了使用成本。  
The cost of LED light source is slightly higher than traditional light source, but the investment can be recovered through energy conservation for one year. LED is maintenance-free light source and can save maintenance cost for a few years and greatly reduce use cost.

**RDB98**

explosion-proof maintenance-free energy-saving lamps (IIB、IIC、DIP)

外形及安装尺寸 Outlines & installation dimensions

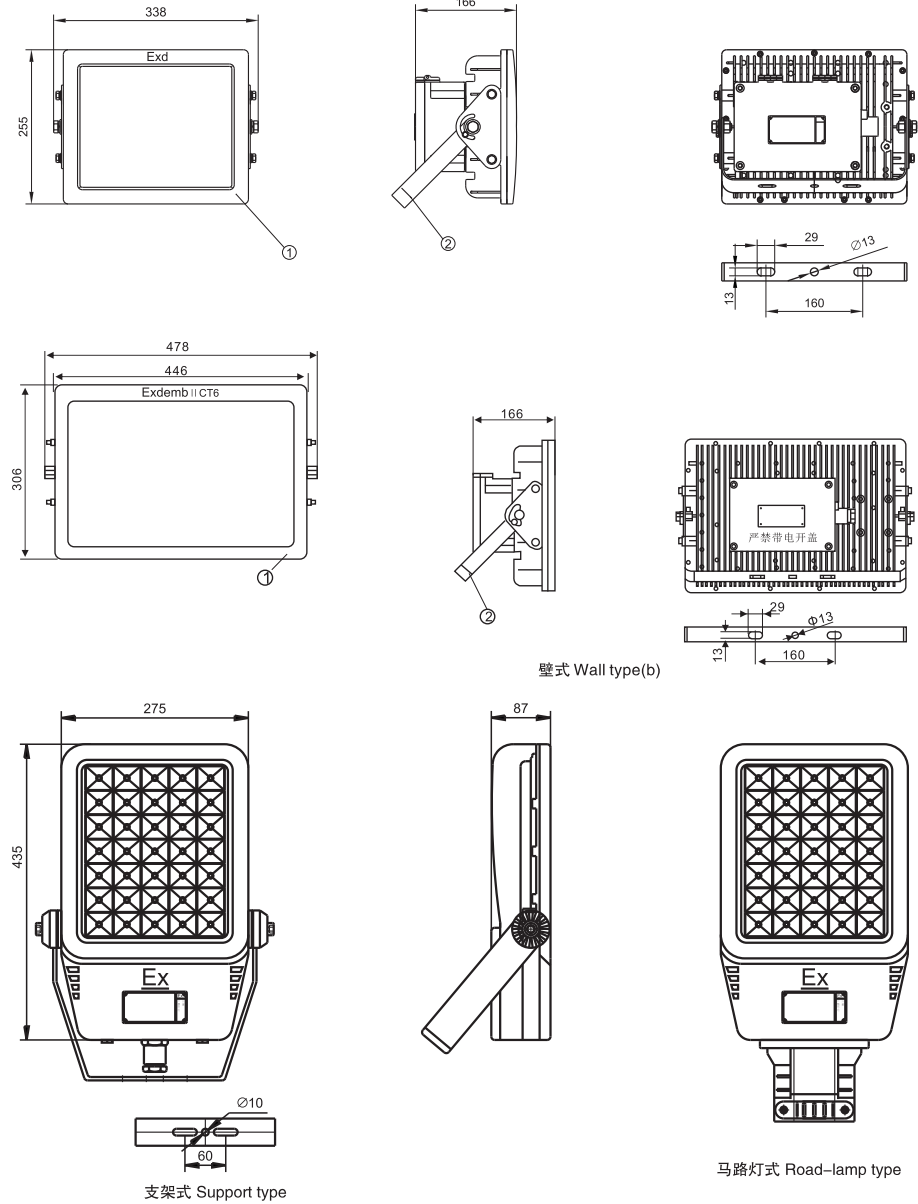

# 防爆灯具

## RDB98

防爆免维护节能灯(IIB、IIC、DIP)

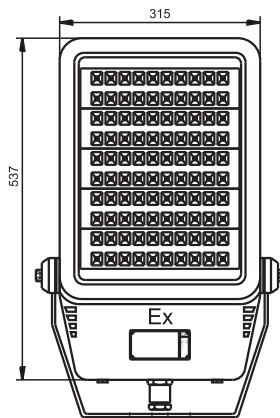

支架式

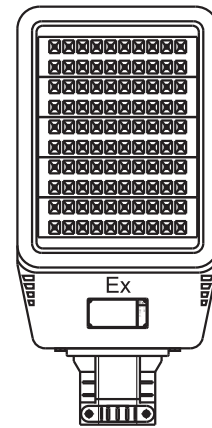

马路灯式

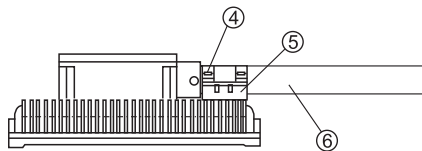

马路灯安装方式

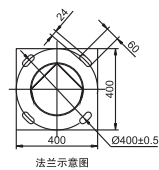

法兰示意图

- 1、防爆灯具 Explosion-proof lamp
- 2、壁式安装架 Wall installation rack
- 3、吸顶式安装架 Ceiling installation rack
- 4、马路灯式抱箍 Road-lamp hoop
- 5、马路灯式支撑座 Road-lamp hoop
- 6、马路灯杆 Road lamp pole

